

LHI-DO Series Linear Light

DUAL OVERDRIVE™

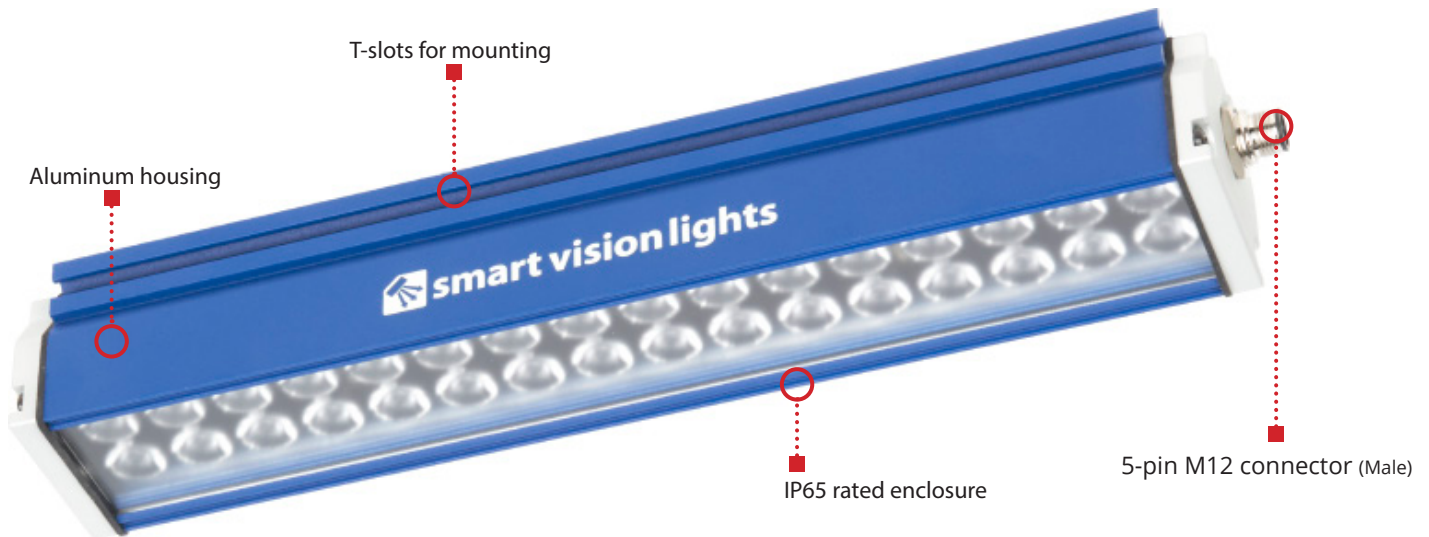

The LHI-DO Series is an OverDrive™ only light source meant to provide external illumination for logistics. This light can be used to create tunnel systems capable of illuminating any package of any size and ensure perfect readability no matter the shape or material. The LHI-DO Series is available in 300- and 600 mm lengths.

LHI-DO SERIES HIGHLIGHTS

Warranty
**10
YEAR**

Tested
**IEC
62471**

Compliant
**CE
ROHS**

Rated
**IP
65**

Connector
**5-PIN
M12**

- ✓ Dual OverDrive features Deca OverDrive with 10x standard light output.
- ✓ Direct connect and control through camera's trigger output.
- ✓ Built for high speed conveyor systems.
- ✓ Compatible with most common major machine vision cameras.
- ✓ Designed for use with a polarizer.



REV 08/17/23

SPECIFICATIONS

	Deca OverDrive Operation	Standard OverDrive™ Operation
Electrical Input	24 VDC +/- 5%	
Input Current	0.97 A average max. per 300 mm segment Peak 2.3 A charge rate per 300 mm segment	
Input Power	23.2 W max. per 300 mm segment	
PNP Trigger	2 mA @ 4 VDC 7 mA @ 12 VDC 13.4 @ 24 VDC	
NPN Trigger	9.9 mA @ Common (0VDC)	
Trigger Input	PNP > +3.3 VDC (24 VDC max.) to activate or NPN > GND (<1.4 VDC) to activate (not both)	
Mode Control	Connect pin 5 to 1-10 VDC (10 - 100% output); 24 VDC (Max)	
Strobe Duration	Min. 10 µs Max. 1 ms ¹	Beginning at 1 ms ¹ Max. 5 ms
Strobe Trigger Latency	6 µs	
Strobe Frequency	Max 4 kHz or 1 / Duty Cycle as calculated, whichever is less. ²	
Duty Cycle	3.5% ²	
Analog Intensity	The output is adjustable from 50% - 100% of intensity limit by a 1 - 9 VDC signal. Jumpering pin 5 to pin 1 will provide maximum intensity.	Not applicable
Connection	5-pin M12 connector	
Operating Temperature	-10° - 40° C (14° - 104° F) RH max 80% non-condensing humidity	
Storage Temperature	-20° to 70° C (-4° to 158° F) RH max 80% non-condensing humidity	
IP Rating	IP65	
Weight	LHI300-DO 2.0 lbs 0.9 kg LHI600-DO 3.6 lbs 1.63 kg	
Compliances (Pending)	CE, IEC-62471, RoHS, UL, CSA, FCC, KCC Pending	
Warranty	10 years ³	

¹ The LHI-DO Series operates in Dual OverDrive™ from 25 µs to 1 ms. After 1 ms, standard OverDrive™ turns on. See page 6 for more information.

² See page 6 for more information.

³ See SmartVisionLights.com/warranty for details.

WIRING CONFIGURATION

OVERDRIVE™ OPERATION MODE

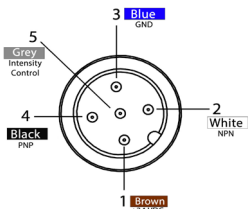

Pin layout for light (Male Connector)

Pins	Function	Signal	Wire Color
1	Power In	+24VDC	BROWN
2	NPN	Sinking Signal	WHITE
3	GND	Ground	BLUE
4	PNP	Sourcing Signal	BLACK
5	Intensity Control	1-10VDC	GREY

For maximum intensity, tie pin 5 to pin 1 at +24VDC.

For proper light function, apply either a PNP or NPN signal, not both.

Failure to supply light with correct input current will result in inconsistent lighting behavior.

(see Product Specifications for requirements)

LIGHTING PATTERNS

Smart Vision Lights recommends the LHI-DO Series be used at a working distance between 500 mm to 2000 mm. Illuminance values taken on white light - 5700K

10° lighting patterns

Illuminance vs. Working Distance

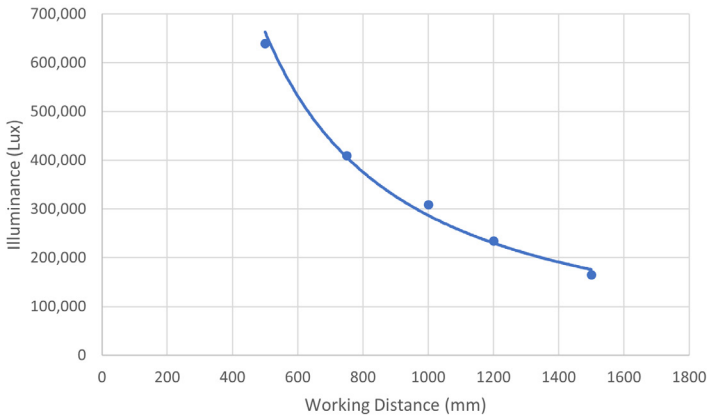

Beam Size at 80% Max Intensity vs. Working Distance

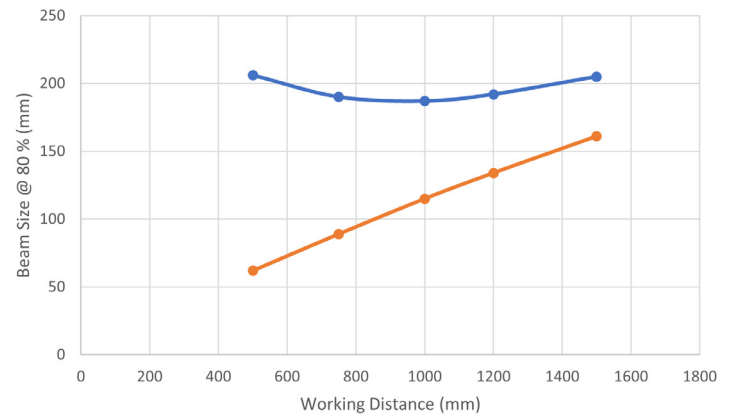

14° lighting patterns

Illuminance vs. Working Distance

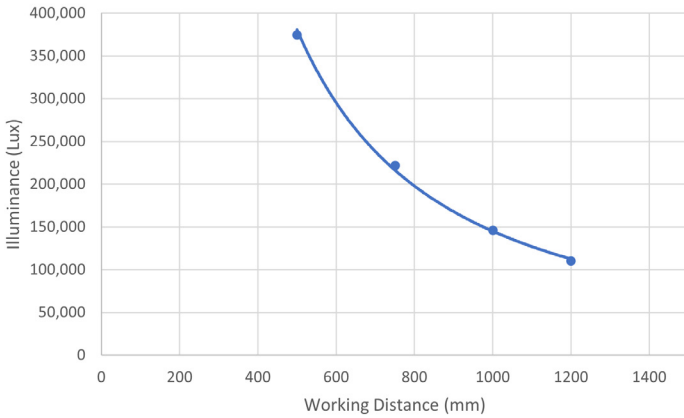

Beam Size at 80% Max Intensity vs. Working Distance

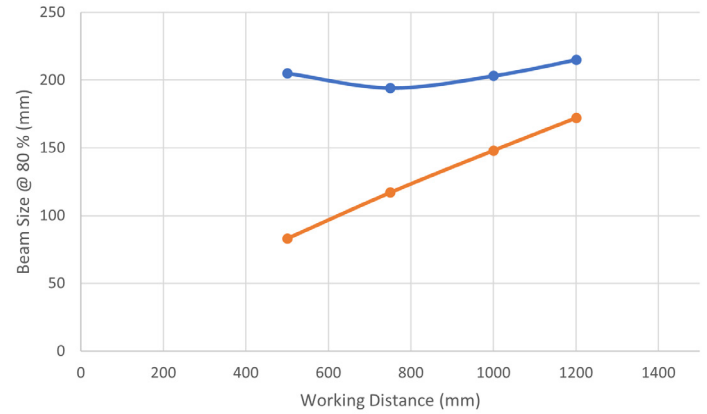

LIGHTING PATTERNS (continued)

Smart Vision Lights recommends the LHI-DO Series be used at a working distance between 500 mm to 2000 mm. Illuminance values taken on white light - 5700K

30° lighting patterns

Illuminance vs. Working Distance

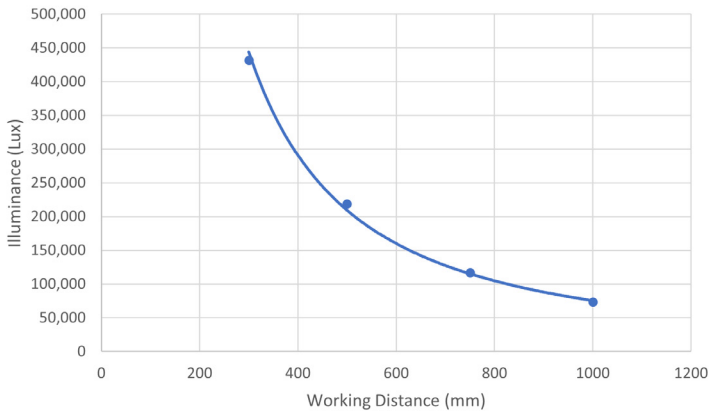

Beam Size at 80% Max Intensity vs. Working Distance

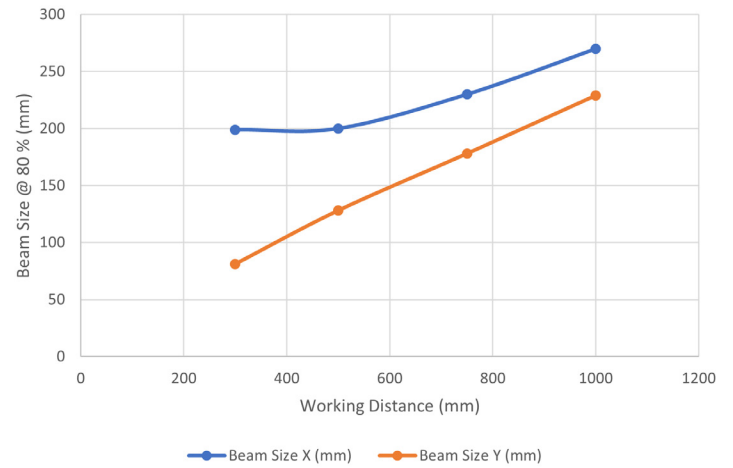

BEAM PATTERNS

Smart Vision Lights recommends the LHI-DO Series be used at a working distance between 300 mm to 1500 mm. Illuminance values taken on white light - 5700K

10° lighting patterns

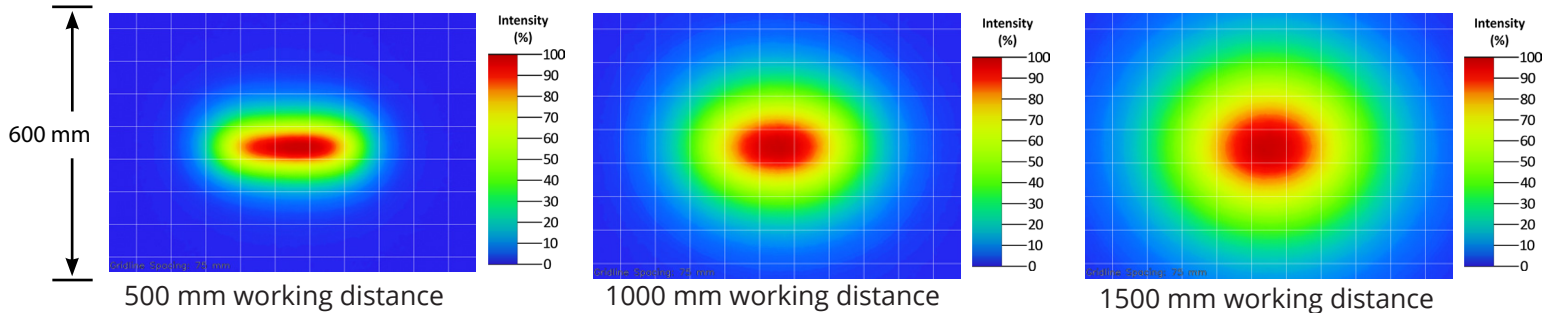

14° lighting patterns

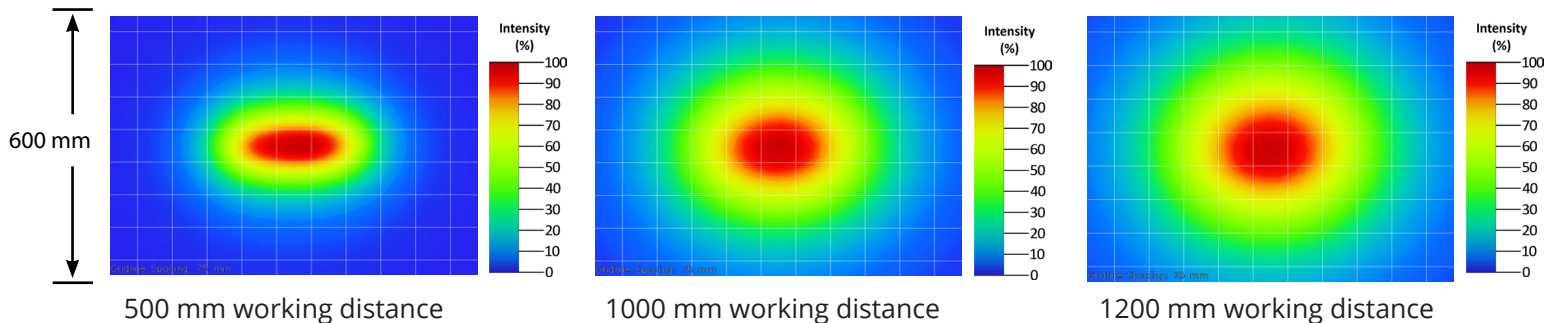

BEAM PATTERNS (continued)

Smart Vision Lights recommends the LHI-DO Series be used at a working distance between 300 mm to 2000 mm. Illuminance values taken on white light - 5700K

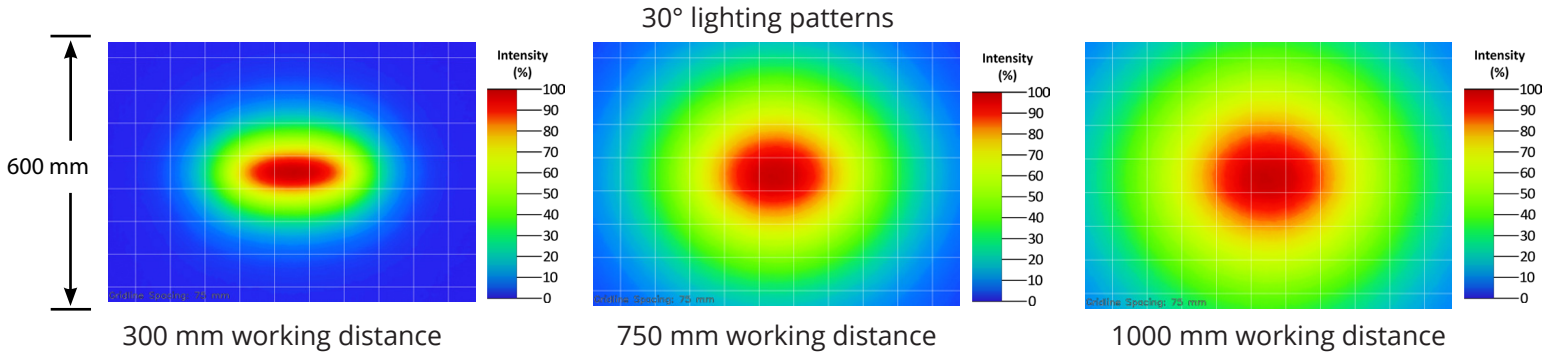

LENS OPTICS

NARROW

Narrow, 10° angle-cone lenses create a narrow beam of illumination and are used for the longest working distances.



WIDE

Wide, 30° angle-cone lenses create the largest area of illumination. They create a floodlight effect and can be used for the shortest working distances.

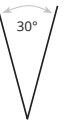

NARROW (Standard)

Narrow, 14° angle-cone lenses create are standard. They create a narrow beam of illumination and are used for long working distances.



MOUNTING

T-Slots are located along the bottom and sides of the LHI-DO Series light.

The LHI-DO Series comes with two T-bolts, two washers, and two nuts

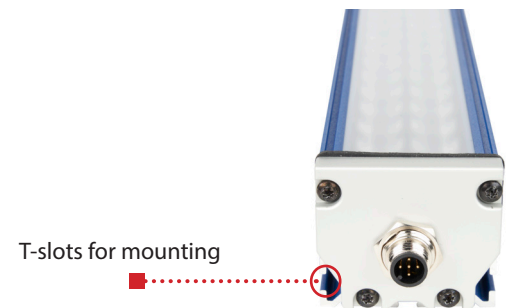

EYE SAFETY

According to IEC 62471:2006. Full documentation available upon request with purchase of product.

Notice

Exempt Group: No photobiological hazard to eyes or skin even for continuous, unrestricted use. Applicable for wavelength 625.

Caution

Risk Group 1: Possibly hazardous optical radiation emitted from this product. Do not stare at operating lamp. May be harmful to eyes. Safe for most applications except prolonged exposure. Applicable for wavelength WHI.

ILLUMINATION

The LHI-DO Series works best for:

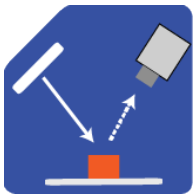

Bright Field

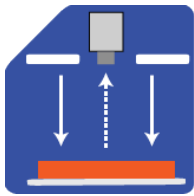

Direct Lighting

DUTY CYCLE

Dual OverDrive lights will always begin the first 1 ms of operation in Deca OverDrive, followed by a shift down to Standard OverDrive for the remaining trigger, up to an additional 5 ms maximum for the LHI-DO Series.

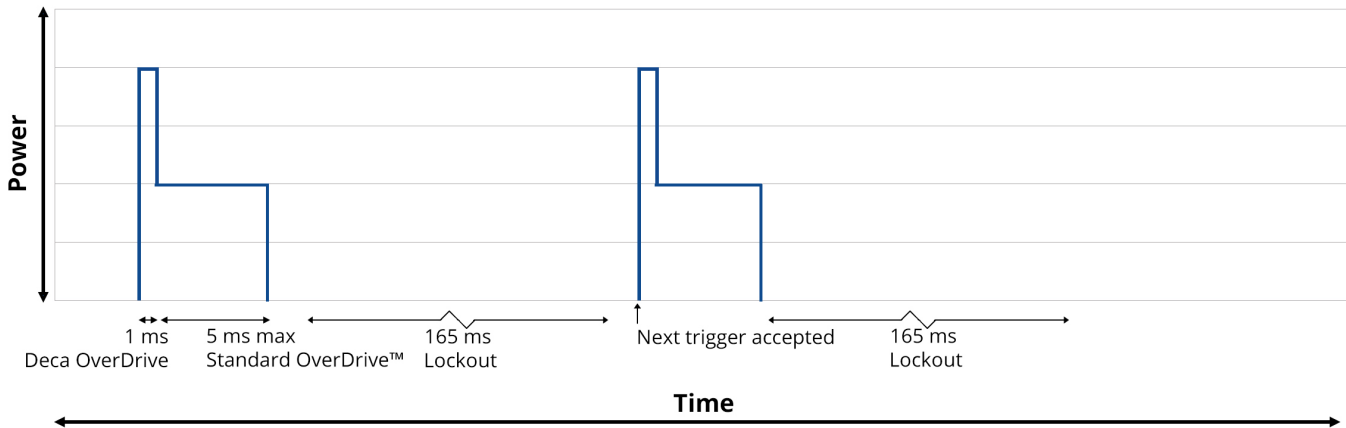

The duty cycle of Dual OverDrive on the LHI-DO Series is 3.5%.

To calculate the lockout period, use the following formula:

$$\frac{\text{Strobe Duration}}{\text{Duty Cycle}} - \text{Strobe Duration} = \text{Lockout Period} \quad \text{Example: } \frac{25 \mu\text{s}}{.035} - 25 \mu\text{s} = 690 \mu\text{s Lockout Period}$$

To calculate the strobes per second, use the following formula:

$$\frac{\text{Duty Cycle}}{\text{Strobe Duration (in seconds)}} = \text{Strobes Per Second} \quad \text{Example: } \frac{.035}{.000025 \text{ sec}} = 1,400 \text{ Strobes Per Second}$$

SAFESTROBE™

SafeStrobe™ is a unique technology that applies safe working parameters to ensure high current LEDs are not damaged by driving them beyond their limits, such as maximum strobe time or duty cycle. This is especially beneficial for overdriving our high current LEDs.

DUAL OVERDRIVE

Dual OverDrive provides both standard OverDrive™ and Deca OverDrive modes from a single integrated driver. Users can select the lighting mode via the strobe duration. Dual OverDrive will always begin with 1 ms of Deca OverDrive, followed by Standard OverDrive™.

Deca OverDrive provides up to 10x the amount of output as traditional continuous operation.



HIDDEN STROBE™



Hidden Strobe works best in applications with short exposure times and a high repetition rate. As the rest period increases, and / or the frequency decreases, some strobing effects may become noticeable. This is due to the nature of overdrive, as all overdrive lights must have a period of rest called the duty cycle. However, the strobe effect will **always** be less noticeable in a light featuring Hidden Strobe than in a light without it.

Human vision is complex and highly circumstantial. There is no one-size-fits-all solution for maximizing the effect of Hidden Strobe™. However, setting the strobe duration to 1 ms or less is a good starting point that will work in many cases.



PART NUMBER GUIDE

LHI - **DO** - - - -

<p>SIZE: 300 mm 600 mm</p>	<p>HIDDEN STROBE™: Leave blank for none HS = Hidden Strobe™</p>	<p>COLOR:  </p>	<p>LENS: N14 = Narrow (14°, Standard) N10 = Narrow (10°) W30 = Wide (30°)</p>	<p>LINEAR POLARIZER: Leave blank for none LPI = Factory Installed</p>
---	---	--	---	---

Part Number Examples:

LHI300-DO-N14-625 LHI300-DO, 625 nm Red Wavelength, Standard 14° Lens Configuration

LHI600-DO-WHI-W30-LPI LHI600-DO, White Wavelength, Wide Lens 30°, Linear Polarizer

Additional wavelengths and lens options available upon request.

ACCESSORIES

Power Cables	
	
Lengths	Part Number
5 m	5PM12-5
10 m	5PM12-10
15 m	5PM12-15

Mount	
	
Description	Part Number
3-Axis Pan and Tilt Mount	PB300-M5

Linear Polarizer	
	
Description	Part Number
LHI Linear Polarizer Kit	LTF300-LP
LHI Linear Polarizer Kit	LTF600-LP

Mounting Kit	
	
Description	Part Number
M5x12 mm T-bolt	SC0161
Stainless Steel Nycon Insert Lock Nut	NU0022
Stainless Steel Flat Washer	WA0018

Light comes with two T-bolts, two nuts, and two washers.

PRODUCT DRAWINGS (LHI300-DO)

CAD files are available on our website. Drawings are in mm.

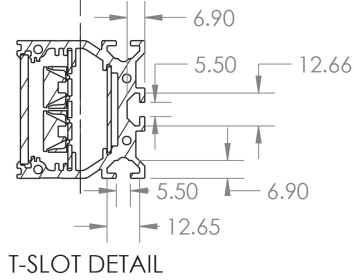
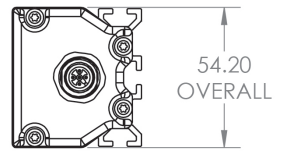
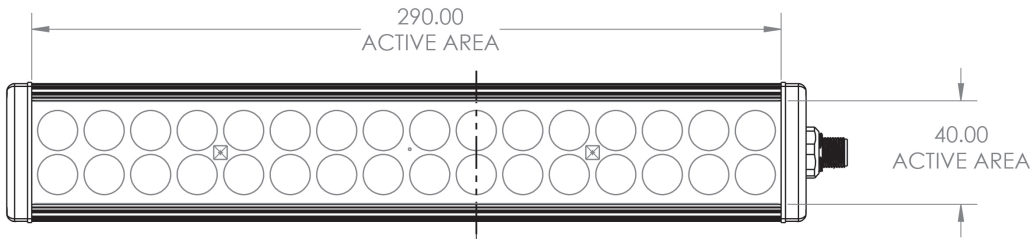
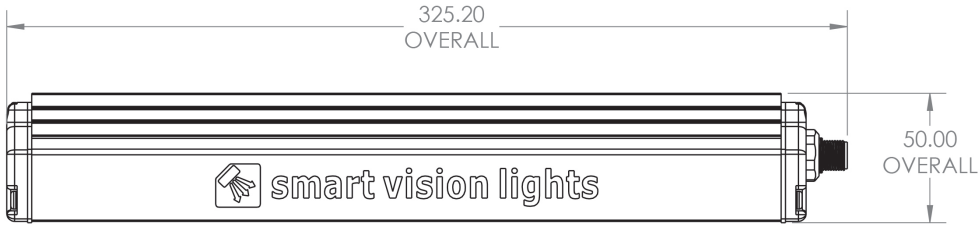

PRODUCT DRAWINGS (LHI600-DO)

CAD files are available on our website. Drawings are in mm.

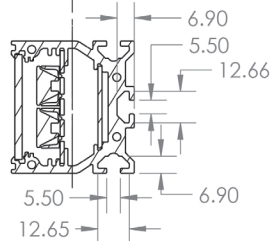
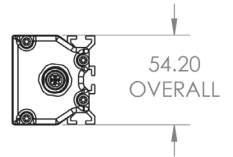
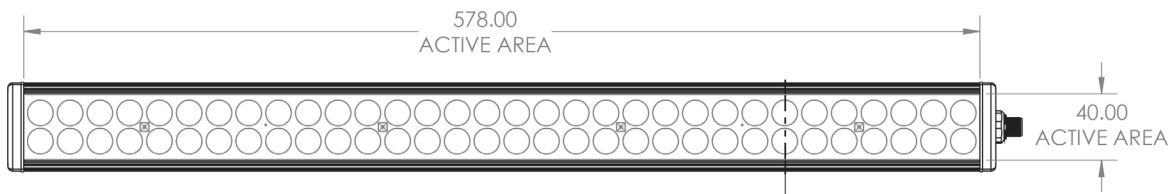

T-SLOT DETAIL
SCALE 2:1

GLOSSARY

This glossary covers all Smart Vision Lights product families; some content in this section may not apply to this specific light.

TERMINOLOGY

Continuous Operation The light stays on continuously.

OverDrive™ Integrated driver that produces a high-current strobe to the LEDs to drive them beyond their nominal continuous operation output.

Multi-Drive™ Integrated driver that combines continuous operation and OverDrive™ strobe mode

NanoDrive™ Integrated driver that provides fast switching where the light can go from off to on in less than 500 ns.

Built-in Driver The driver contained within the light that controls the current to the LEDs and provides PNP, NPN, and analog dimming controls.

SmartVisionLink™ Integrated feature that enables lighting control through the Bluetooth module and app.

Camera to Light Connect the light directly to the camera, without the need for additional controllers or equipment.

Polarizers Filters that reduce reflections on specular surfaces.

Diffusers Widens the angle of emission by scattering light in all directions.

Pattern Area Lighting Modulated lighting pattern placed over a backlight's surface used to enhance defect detection on transparent and glossy surfaces

SafeStrobe Limiter to keep the light in safe working parameters.

Direct Connect Connect lights in a series without the use of cables.

Daisy-Chain Connect lights in a series with the use of cables.

TYPES OF ILLUMINATION

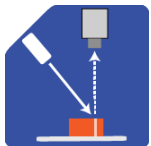

Projector

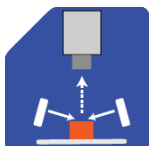

Dark Field

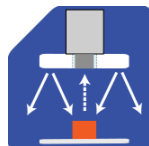

Radial



Bright Field

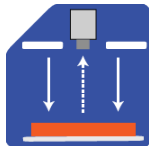

Direct

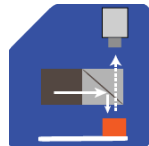

Axial

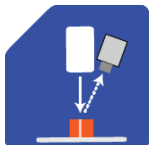

Line

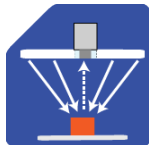

Diffuse Panel

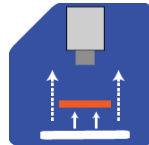

Backlight

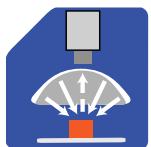

Dome
"Light Tent"

COMMON COLOR / WAVELENGTHS LEGEND

Wavelengths options range from 365 nm to 1650 nm.*
Additional wavelengths available for many light families.

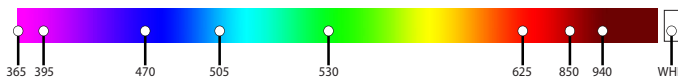

*See Part Number section for **this light's** available standard wavelengths.



Shortwave Infrared LEDs are available in 1050 nm, 1200 nm, 1300 nm, 1450 nm, 1550 nm, and 1650 nm.*

*Check Part Number section to see if **this light** is available in SWIR wavelengths.



ISO 9001:2015 Certified QMS